

LES
**PRODUITS
BLEUS**

L'OFFRE
CHEMINS DE CÂBLES
ET SUPPORTAGE
100% NIEDAX

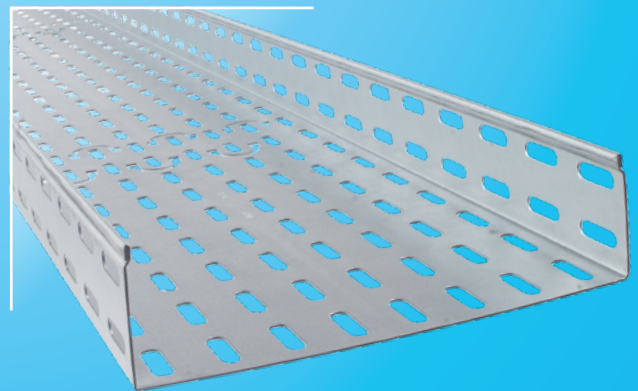
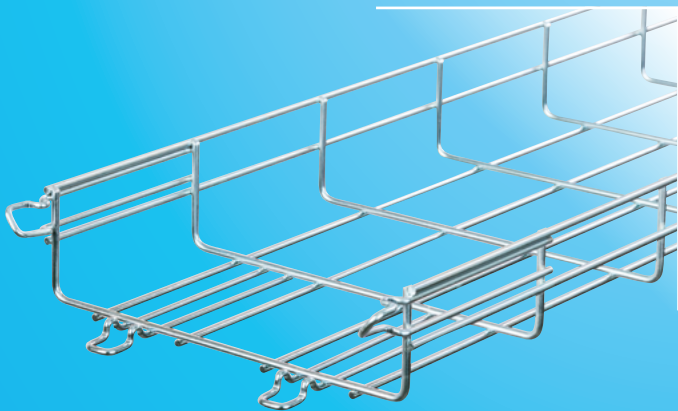

LES PRODUITS BLEUS

L'offre chemins de câbles et supportage **100% NIEDAX**

- **Une offre 100% EFFICACE**

Des basiques chantier qui répondent à vos besoins quotidiens.

- **Une offre 100% DISPONIBLE**

Stockée chez votre distributeur partenaire*.

- **Une offre 100% RECONNAISSABLE**

Par un packaging et une signalétique produits adaptés.

- **Une offre 100% MADE IN FRANCE**

2 sites de production (62-72), une équipe commerciale à votre disposition.



UNE MARQUE CERTIFIÉE ET ENGAGÉE



Pour plus d'information rendez-vous sur notre site web

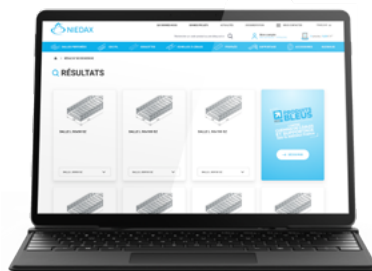

Découvrez notre équipe commerciale



RAILS TELEX ET PROTECTION DE CABLES PRC

	m	Désignation	Code
SZ	2	TELEX C 30 2M	448002
	2	TELEX C 50 2M	448003
	3	PROTECTION DE CABLES PRC 30	545001
	3	PROTECTION DE CABLES PRC 60	545002

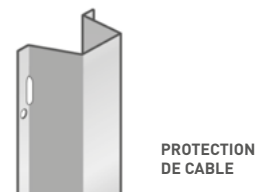
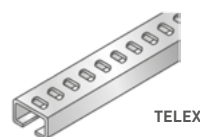

PROFILÉS

	m	Désignation	Code
SZ	3	L A560 24X24X1.75 3M	014051
	3	L A560 24X48X1.75 3M	014054
	3	L A560 48X48X1.75 3M	014057
SZ	3	UD A540 24X24X1.75 3M	015003
SZ	3	Z A570 24X24X24X1.75 3M	016002
SZ	3	Z A570 24X48X24X1.75 3M	016005
	3	Z A570 48X48X48X1.75 3M	016008

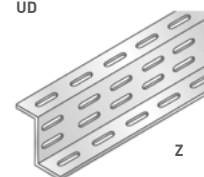
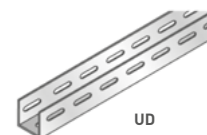
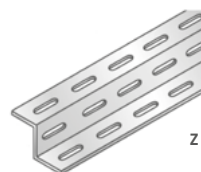
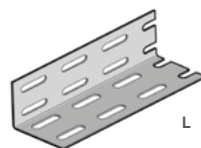

DALLES PERFORÉES PS*

	m	Désignation	Code
SZ	3	DALLE PS 27x50x0,75	001001
	3	DALLE PSN 27x75x0.75	001002
	3	DALLE PSN 27x100x0.75	001003
	3	DALLE PSN 27x147x0.75	001005
	3	DALLE PSN 27x195x1.00	001007
	3	DALLE PS 51x50x0.75	001050
	3	DALLE PSN 51x75x0.75	001051
	3	DALLE PSN 51x100x0.75	001052
	3	DALLE PSN 51x147x1.00	001054
	3	DALLE PSN 51x195x1.00	001056
GC	3	DALLE PSN 51x316x1.25	001061
	3	DALLE PSN 51x412x1.50	001065
	3	DALLE PSN 51x507x1.50	001069
	3	DALLE PS 51x50x1.00	001250
	3	DALLE PSN 51x100x1.00	001252
	3	DALLE PSN 51x147x1.20	001254
	3	DALLE PSN 51x195x1.20	001256

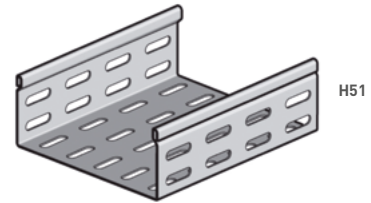
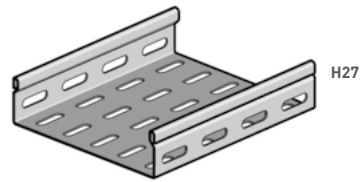

COUVERCLES & CLIPS

	m	Désignation	Code
SZ	2	COUVERCLE C02 50	005001
	2	COUVERCLE C02 100	005003
	2	COUVERCLE C02 147	005005
	2	COUVERCLE C02 195	005007
	2	COUVERCLE C02 316	005012
	I	100 p	CLIPS C03

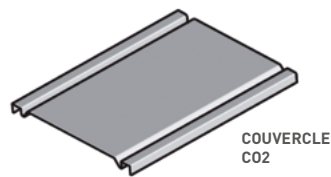

ACCESSOIRES

	p	Désignation	Code
SZ	20	ECLISSE EMBOITABLE EE27	009200
	20	ECLISSE EMBOITABLE EE51	009201
	20	ECLISSE EK27 (PS 50 A 195)	009600
	20	ECLISSE EK51 (PS 50 A 195)	009601
	50	ECLISSE PLATE 24	402001
	50	ECLISSE PLATE 48	402002
GC	50	ECLISSE PLATE 48	404002
SZ	50	ECLISSE CORNIERE EC 24	435001
	50	ECLISSE CORNIERE EC 48	435002
GC	50	ECLISSE CORNIERE EC 48	436002
SZ	3m	CORNIERE LPSU 48	400061
SZ	10	ECLISSE D'ANGLE H 48	421955
AE	30	AGRAFE T-CLIP 16-35	651313

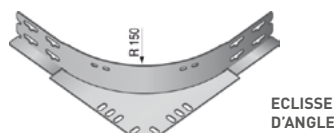
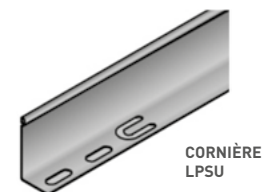
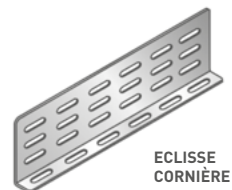
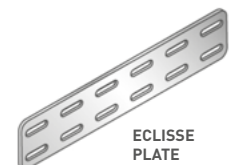
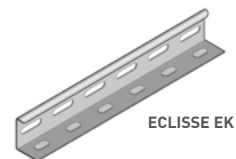
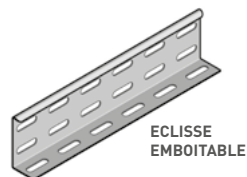

DALLES PERFORÉES BS*

	m	Désignation	Code
SZ	3	DALLE BS 24x50	401001
	3	DALLE BS 24x75	401002
	3	DALLE BS 24x100	401003
	3	DALLE BS 24x147	401005
	3	DALLE BS 24x195	401007
	3	DALLE BS 48x50	401015
	3	DALLE BS 48x75	401016
	3	DALLE BS 48x100	401017
	3	DALLE BS 48x147	401019
	3	DALLE BS 48x195	401021
GC	3	DALLE BS 48x316	401024
	3	DALLE BS 48x412	401026
	3	DALLE BS 48x507	401028
	3	DALLE BS 48x50	403015
	3	DALLE BS 48x75	403016
	3	DALLE BS 48x100	403017
	3	DALLE BS 48x147	403019
3	DALLE BS 48x195	403021	

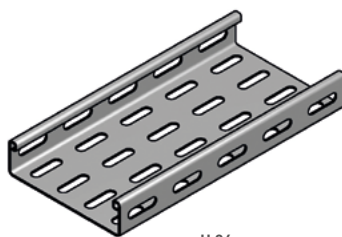

H 24

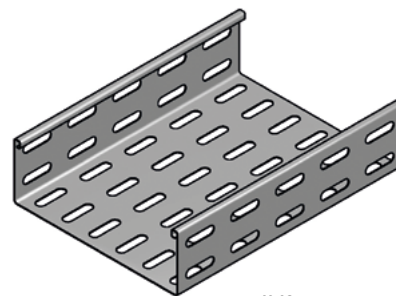

H 48

COUVERCLES & CLIPS

	m	Désignation	Code
SZ	3	COUVERCLE NERVURE L 50	415001
	3	COUVERCLE NERVURE L 100	415003
	3	COUVERCLE NERVURE L 147	415005
	3	COUVERCLE NERVURE L 195	415007
	3	COUVERCLE NERVURE L 316	415010
SZ	20	CLIPS RS	644024

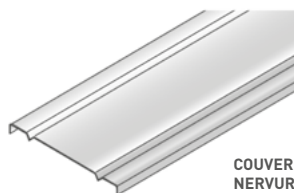

COUVERCLE NERVURE



CLIPS RS

ACCESSOIRES

	p	Désignation	Code
SZ	50	ECLISSE RAPIDTOL ER 48	402010
	50	ECLISSE PLATE 24	402001
	50	ECLISSE PLATE 48	402002
GC	50	ECLISSE PLATE 48	404002
SZ	50	ECLISSE CORNIERE EC 24	435001
	50	ECLISSE CORNIERE EC 48	435002
GC	50	ECLISSE CORNIERE EC 48	436002
SZ	3m	CORNIERE LPSU 48	400061
SZ	10	ECLISSE D'ANGLE H 48	421955
AE	30	AGRAFE T-CLIP 16-35	651313
PVC	10	JONC PROTECTION 10M STD GRIS	040037

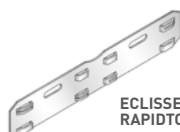

ECLISSE RAPIDTOL

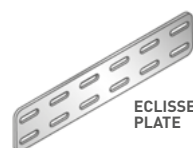

ECLISSE PLATE

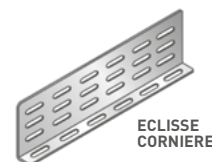

ECLISSE CORNIERE

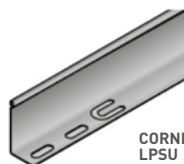

CORNIERE LPSU

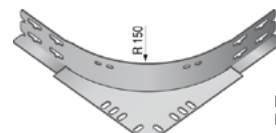

ECLISSE D'ANGLE



AGRAFE T-CLIP

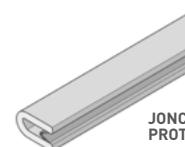

JONC PROTECTION

FIL AUTOMATIQUE CITO



	m	Désignation	Code
EZ	3	MTC 30x50	711215
	3	MTC 30x100	711222
	3	MTC 54x50	711260
	3	MTC 54x100	711277
	3	MTC 54x150	711284
	3	MTC 54x200	711291
	3	MTC 54x300	711314
	3	MTC 54x400	711321
	3	MTC 54x500	711338
GC	3	MTC 54x50	712069
	3	MTC 54x100	712076
	3	MTC 54x150	712083
	3	MTC 54x200	712090
	3	MTC 54x300	712113
	3	MTC 54x400	712120
	3	MTC 54x500	712137

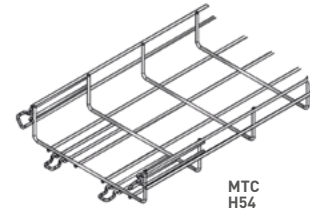
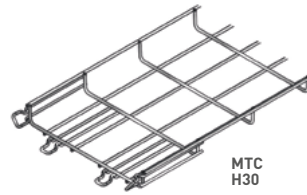

ÉLÉMENTS DE RACCORDEMENT MTCE

	p	Désignation	Code
EZ	1	ELEMENT MTCE 54x100 EZ	711512
	1	ELEMENT MTCE 54x150 EZ	711536
	1	ELEMENT MTCE 54x200 EZ	711550
	1	ELEMENT MTCE 54x300 EZ	711574

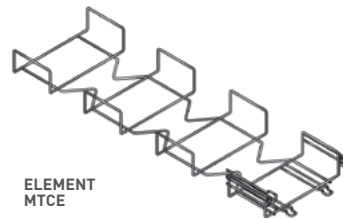

ASSEMBLAGES DROITS OU COUDÉS

	m	Désignation	Code
EZ	50	ECLISSE KU20	552134
	50	PETITE ECLISSE U 20	552042
	50	CONTRE ECLISSE U 30	552043
	50	KIT RAPIDE U20/U30	552050
GM	50	KIT RAPIDE U20/U30	553050

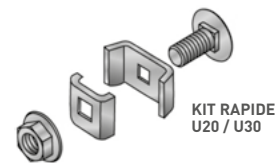

SUPPORTAGE ET ACCESSOIRES FIL

	p	Désignation	Code
SZ	50	CLAME U40	552032
	50	CLIPS T25 (largeur maxi 200 mm)	552129
	20	SUSPENTE UFA	552033
	50	PATTE PUF (largeur < 150 mm)	552036
	10	SUPPORT SUL50	552118
	20	SUPPORT UFU	552037
LT	25	GRIFFE GMT 10-50	651311
AE	40	AGRAFE F-CLIP 16-35	651314



SUPPORTAGE LÉGER

p	Désignation	Code
SZ	50 EQU FIXATION 90x150	613123
	50 EQU FIXATION 90x225	613124
SZ	10 CONSOLE CU 80	011020
	10 CONSOLE CU 120	011021
	10 CONSOLE CU 160	011010
	10 CONSOLE CU 240	011011
	10 CONSOLE CU 320	011012
SZ	10 SUPPORT CCU 80x140x160	012349
	10 SUPPORT CCU 120x180x160	012350
	10 SUPPORT CCU 120x180x240	012352
SZ	25 SFT 50-100	747050
SZ	10 GRKHV 173	710626

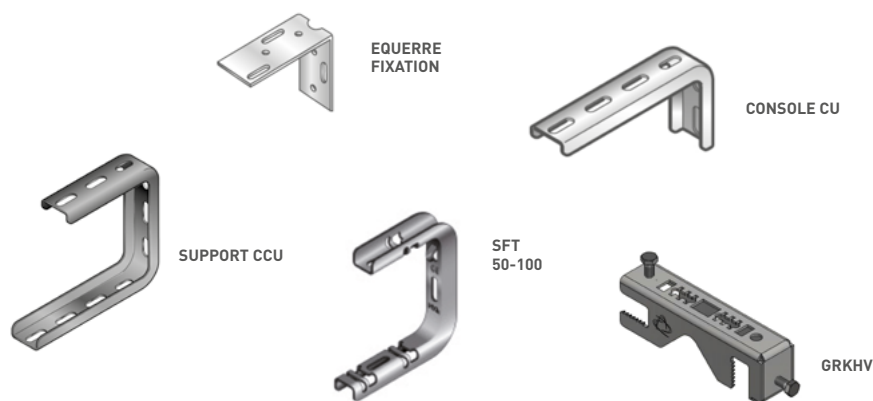

SUPPORTAGE MOYEN

p	Désignation	Code
SZ	3 m RAIL S100U 3M	747111
SZ	20 CONSOLE UFL-10	747001
	20 CONSOLE UFL-15	747002
	20 CONSOLE UFL-20	747003
	20 CONSOLE UFL-30	747005
SZ	20 SUPPORT UFC-10 120x185x100	747010
	20 SUPPORT UFC-15 120x185x150	747011
	20 SUPPORT UFC-20 120x185x200	747012
	20 SUPPORT UFC-30 170x185x300	747014
SZ	3 m ECHELLE S150U 3M EP2	757102
SZ	20 CONSOLE S150U C100N	757021
	20 CONSOLE S150U C200N	757023
	20 CONSOLE S150U C300N	757024
	20 CONSOLE S150U C400N	757025
	10 CONSOLE S150U C500N	757026
SZ	20 GOUSSET S150U ERGOT	757201
SZ	10 GOUSSET G 10 B	613021
GC	1 PENDARD HU 4530 300	710667
	1 PENDARD HU 4530 500	710669
	1 PENDARD HU 4530 700	710671
	1 PENDARD HU 4530 1000	710674
PVC	50 EMBOUT SKU 4530	710694
GC	50 ENTRETOISE HDS 4530	710691

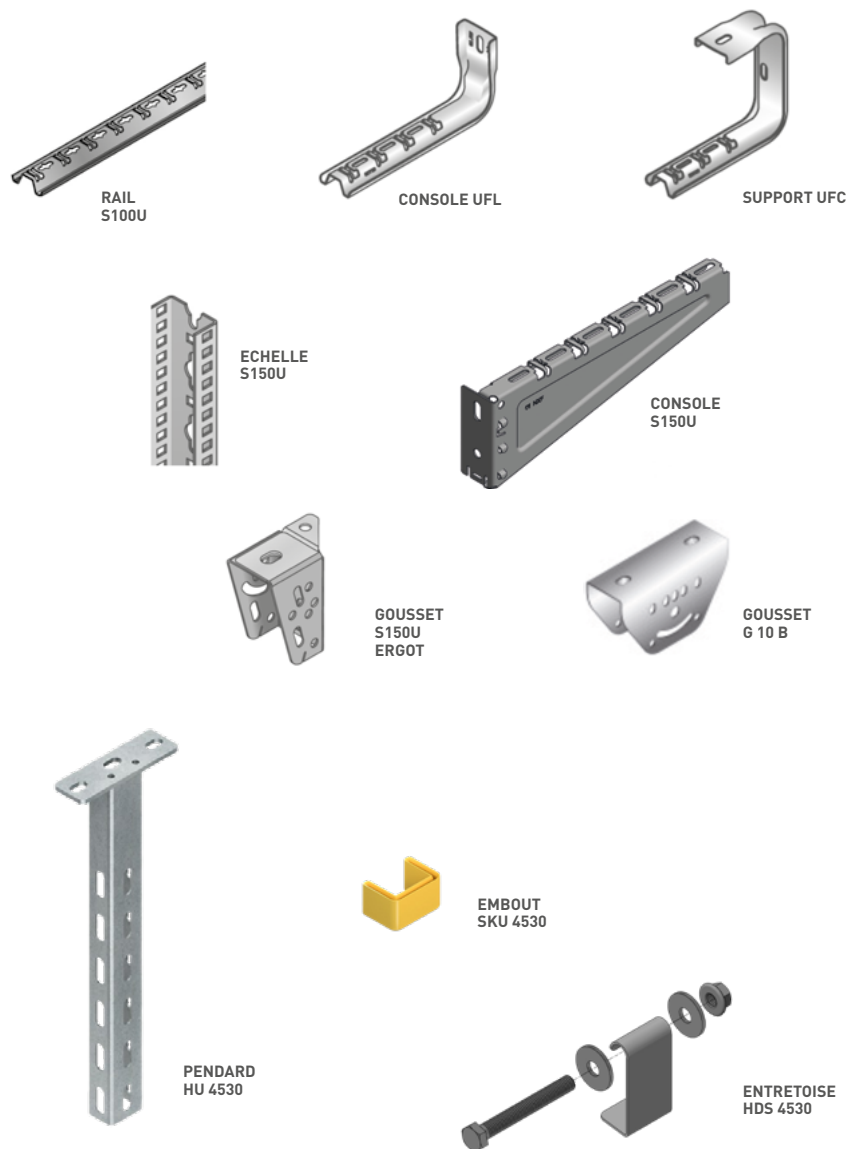

SUPPORTAGE LOURD

p	Désignation	Code
SZ	3 m STRUT 41x41x1.80 P 3M	652001
	3 m STRUT 41x41x2.50 P 3M	652002
SZ	3 m STRUT 41x21x1.80 P 3M	652005
SZ	3 m STRUT 41x41x1.80 PERFORE 3 FACES	652040
EZ	10 CONSOLE STRUT 41x41 350	677072
	10 CONSOLE STRUT 41x41 450	677092
	10 CONSOLE STRUT 41x41 550	677126
	10 CONSOLE STRUT 41x41 650	677070
GC	10 PLAQUE DE TETE STRUT 41	678063
SZ	10 GOUSSET RAPIDE 3U STRUT 41	677066
EZ	100 ECRU RESSORT M6 STRUT	648025
EZ	100 ECRU RAINURE M6 STRUT	648035
	100 ECRU RAINURE M8 STRUT	648037
GC	25 PINCE ÉTRIER STRUT 41x21	678229
	25 PINCE ÉTRIER STRUT41x41	678084
EZ	25 PINCE A POUTRELLE PP8	678302
PEHD	50 BOUCHON STRUT 41x21	687385
	50 BOUCHON STRUT 41x41	687228

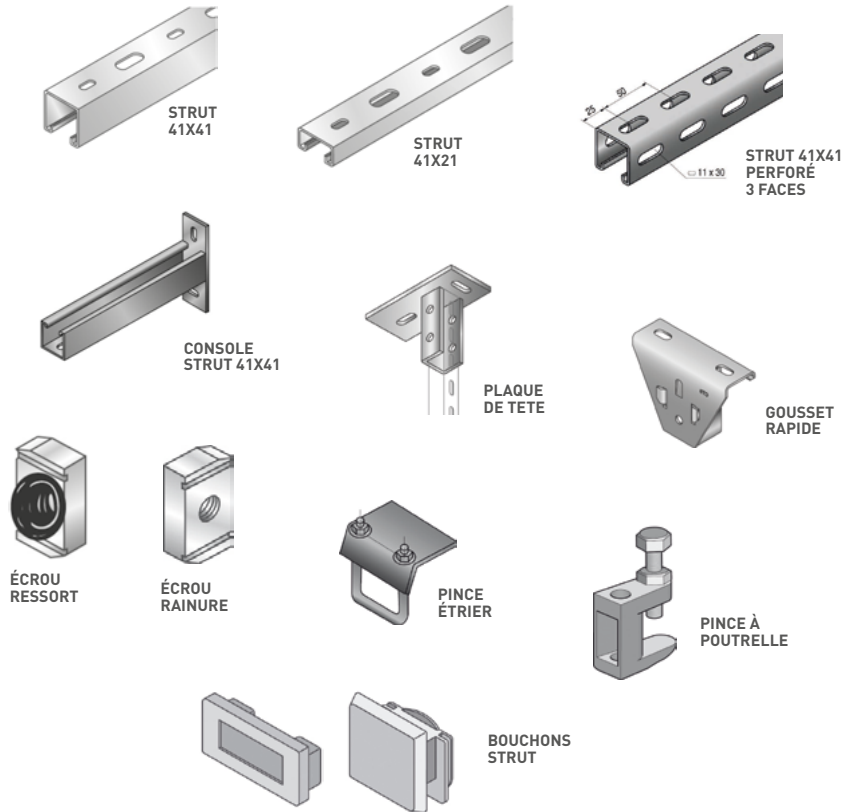

BOULONNERIE ET ACCESSOIRES

BOULONNERIE

p	Désignation	Code
EZ	100 BP TRCC M6x12 HE	648001
	100 BP TRCC M6x15 HE	648002
	100 BP TRCC M6x20 HE	648003
	100 BP TRCC M6x30 HE	648132
GM	100 BP TRCC M6x12 HE	651001
	100 BP TRCC M6x20 HE	651003
EZ	100 BP TRL M6x20 HE	648619
	100 BP TRL M6x30 HE	648005
EZ	100 BOULON TH M8x15 HE	648007
EZ	100 RONDELLE L 8	648020
	100 RONDELLE L 6	648024
EZ	100 GOUPILLE 8x90	023051
EZ	100 ECRU HE M6	648064
	100 ECRU HE M8	648065

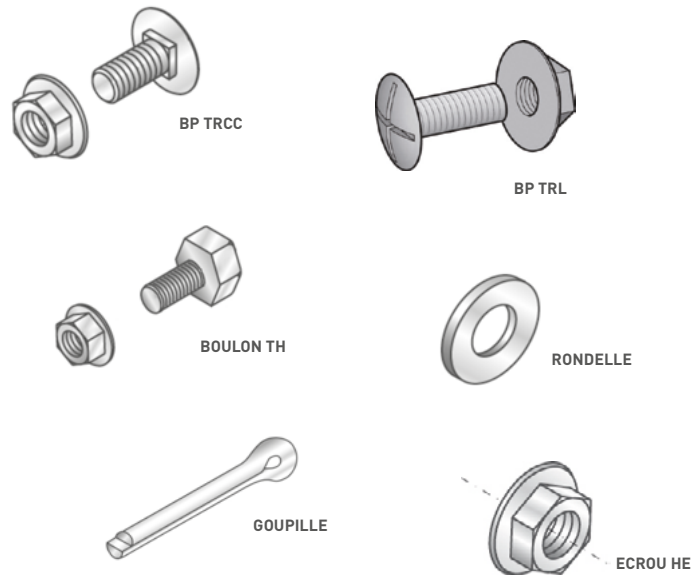

ACCESSOIRES

LT	20 BORNE MT 6-25 MM2	651310
	20 BORNE MT 6-35 MM2	651309

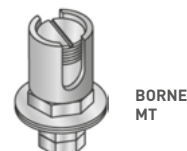



32 avenue de l'Opéra
75002 PARIS

Tél : 01 46 45 70 44

www.niedaxfrance.fr

DISTRIBUÉ PAR :