





BOULONNERIE & FIXATIONS, ACCESSOIRES



Boulonnerie et fixations p. 248



Accessoires p. 254

BOULONNERIE
BOULONS POELIERS TRCC + HE

		Désignation	Code	Masse kg/100
EZ	100	BP TRCC M6x12 HE EZ	648001	0.800
	100	BP TRCC M6x15 HE EZ	648002	0.900
	100	BP TRCC M6x20 HE EZ	648003	0.900
	100	BP TRCC M6x30 HE EZ	648132	1.100
	100	BP TRCC M8x18 HE EZ	648004	1.400
	100	BP TRCC M8x40 HE EZ	648109	2.800
	100	BP TRCC M10x25 HE EZ	648010	3.000
		Désignation	Code	Masse kg/100
GM	100	BP TRCC M6x12 HE GM	651001	0.800
	100	BP TRCC M6x15 HE GM	651002	0.900
	100	BP TRCC M6x20 HE GM	651003	0.900
	100	BP TRCC M6x30 HE GM	651132	1.100
	100	BP TRCC M8x18 HE GM	651004	1.400
	100	BP TRCC M10x25 HE GM	651010	3.000
		Désignation	Code	Masse kg/100
I2	100	BP TRCC M6x12 HE A2/304	030471	0.800
	100	BP TRCC M6x15 HE A2/304	030472	0.900
	100	BP TRCC M6x20 HE A2/304	030473	0.900
	100	BP TRCC M6x30 HE A2/304	649132	1.100
	100	BP TRCC M8x18 HE A2/304	040090	1.400
		Désignation	Code	Masse kg/100
I3	100	BP TRCC M6x12 HE A4/316	529001	0.800
	100	BP TRCC M6x15 HE A4/316	529002	0.900
	100	BP TRCC M6x20 HE A4/316	529003	0.900
	100	BP TRCC M6x30 HE A4/316	529132	1.100
	100	BP TRCC M8x18 HE A4/316	529004	1.400
		Désignation	Code	Masse kg/100
ALU	100	BP TRCC M6x15 HE AL	650002	0.200

Boulons poêliers à embase carrée et écrou à embase crantée (classe 4.8)



BOULONS POELIERS TRL + HE

		Désignation	Code	Masse kg/100
EZ	100	BP TRL M6x12 HE EZ	520617	0.900
	100	BP TRL M6x15 HE EZ	648147	0.900
	100	BP TRL M6x20 HE EZ	648619	1.000
	100	BP TRL M6x30 HE EZ	648005	1.100
	100	BP TRL M6x40 HE EZ	648152	1.200
	100	BP TRL M6x50 HE EZ	648153	1.400
		Désignation	Code	Masse kg/100
GM	100	BP TRL M6x12 HE GM	651617	0.900
	100	BP TRL M6x15 HE GM	651147	0.900
	100	BP TRL M6x20 HE GM	651619	1.000
	100	BP TRL M6x30 HE GM	651005	1.100
	100	BP TRL M6x40 HE GM	651152	1.200
		Désignation	Code	Masse kg/100
I3	100	BP TRL M6x12 HE A4/316	320617	0.900
	100	BP TRL M6x15 HE A4/316	529147	0.900
	100	BP TRL M6x20 HE A4/316	529107	1.000
	100	BP TRL M6x30 HE A4/316	529108	1.100

Boulons poêliers à tête ronde, large, fendue et écrou à embase crantée (classe 4.8)





BOULONNERIE
BOULONS TH + HE



		Désignation	Code	Masse kg/100
EZ	100	BOULON TH M 8x15 HE EZ	648007	1.700
		Désignation	Code	Masse kg/100
GM	100	BOULON TH M 8x15 HE GM	651007	1.700

Boulons à tête hexagonale et écrou à embase crantée (classe 4.8)

VIS TRL

		Désignation	Code	Masse kg/100
EZ	100	VIS TRL M6x12 EZ	023371	0.500
		Désignation	Code	Masse kg/100
GM	100	VIS TRL M6x12 GM	651483	0.500

VIS TH



		Désignation	Code	Masse kg/100
EZ	100	VIS TH M6x20 EZ	648045	0.500
	100	VIS TH M8x15 EZ	648018	1.100
	100	VIS TH M8x20 EZ	648120	1.200
	100	VIS TH M8x25 EZ	648101	1.300
	100	VIS TH M10x20 EZ	648046	2.300
	100	VIS TH M10x25 EZ	648048	2.500
	100	VIS TH M10x30 EZ	648028	2.800
	100	VIS TH M10x50 EZ	648071	3.800
	100	VIS TH M10x60 EZ	502298	4.300
	100	VIS TH M12x25 EZ	648021	3.600
	100	VIS TH M12x35 EZ	648150	4.300
	100	VIS TH M12x50 EZ	648047	5.400
		Désignation	Code	Masse kg/100
GM	100	VIS TH M6x20 GM	651045	0.600
	100	VIS TH M8x15 GM	651058	1.100
	100	VIS TH M8x20 GM	651120	1.200
	100	VIS TH M8x25 GM	651117	1.500
	100	VIS TH M10x25 GM	651144	2.500
	100	VIS TH M10x30 GM	651028	3.300
	100	VIS TH M12x25 GM	651021	3.600
	100	VIS TH M12x35 GM	651150	4.300
	100	VIS TH M12x50 GM	651009	5.400
		Désignation	Code	Masse kg/100
I3	100	VIS TH M8x15 A4/316	529018	1.100
	100	VIS TH M8x20 A4/316	529120	1.200
	100	VIS TH M8x25 A4/316	529101	1.500
	100	VIS TH M8x50 A4/316	221492	2.100
	100	VIS TH M10x25 A4/316	529048	2.500
	100	VIS TH M10x30 A4/316	302319	3.300
	100	VIS TH M12x25 A4/316	529021	3.600
	100	VIS TH M12x35 A4/316	529150	4.300





BOULONNERIE
VIS THE

		Désignation	Code	Masse kg/100
EZ	100	VIS THE M8x20 EZ	648203	1.200
	100	VIS THE M8x50 PART.FILETEE EZ	648204	2.400
	100	VIS THE M8x50 ENT.FILETEE EZ	648202	2.400





ÉCROUS HE

		Désignation	Code	Masse kg/100
EZ	100	HE M6 EZ	648064	0.600
	100	HE M8 EZ	648065	0.600
	100	HE M10 EZ	648081	1.100
	100	HE M12 EZ	648139	1.900
		Désignation	Code	Masse kg/100
I3	100	HE M6 A4/316	529064	0.600
	100	HE M8 A4/316	529065	0.600

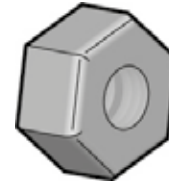
ÉCROUS HU

		Désignation	Code	Masse kg/100
EZ	100	HU M8 EZ	023251	0.500
		Désignation	Code	Masse kg/100
I3	100	HU M10 A4/316	529058	1.200
	100	HU M12 A4/316	529022	1.500



ÉCROUS RESSORT STRUT 41

		Désignation	Code	Masse kg/100
EZ	100	ÉCROU RESSORT M6 STRUT EZ	648025	2.900
	100	ÉCROU RESSORT M8 STRUT EZ	648031	2.800
	100	ÉCROU RESSORT M10 STRUT EZ	648027	3.500
	100	ÉCROU RESSORT M12 STRUT EZ	648013	3.800
		Désignation	Code	Masse kg/100
GM	100	ÉCROU RESSORT M6 STRUT GM	651025	2.900
	100	ÉCROU RESSORT M8 STRUT GM	651031	3.100
	100	ÉCROU RESSORT M10 STRUT GM	651027	3.600
	100	ÉCROU RESSORT M12 STRUT GM	651013	4.400
		Désignation	Code	Masse kg/100
I3	100	ÉCROU RESSORT M6 STRUT A4/316	529025	2.900
	100	ÉCROU RESSORT M8 STRUT A4/316	529031	2.800
	100	ÉCROU RESSORT M10 STRUT A4/316	529027	3.600
	100	ÉCROU RESSORT M12 STRUT A4/316	529013	3.800

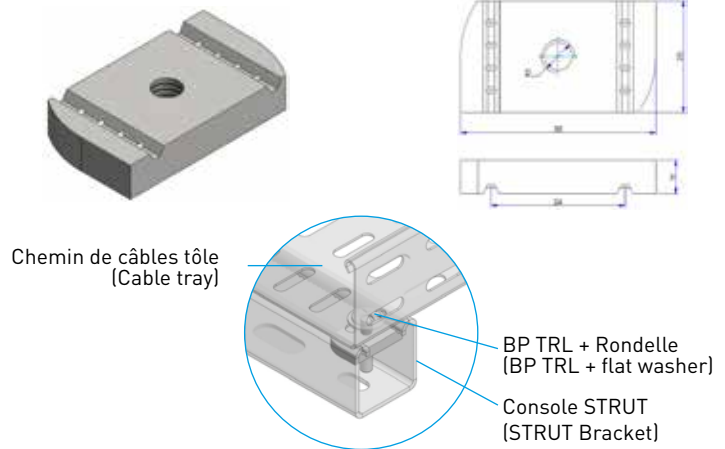

BOULONNERIE
ÉCROUS RAINURE STRUT 41

	p	Désignation	Code	Masse kg/100
EZ	100	ÉCROU RAINURE M6 STRUT EZ	648035	2.900
	100	ÉCROU RAINURE M8 STRUT EZ	648037	2.300
	100	ÉCROU RAINURE M10 STRUT EZ	648038	3.300
	100	ÉCROU RAINURE M12 STRUT EZ	648039	3.600
GM	100	ÉCROU RAINURE M6 STRUT GM	651035	2.700
	100	ÉCROU RAINURE M8 STRUT GM	651037	3.100
	100	ÉCROU RAINURE M10 STRUT GM	651038	3.400
	100	ÉCROU RAINURE M12 STRUT GM	651039	3.400
I3	100	ÉCROU RAINURE M6 STRUT A4/316	529035	3.000
	100	ÉCROU RAINURE M8 STRUT A4/316	529037	3.320
	100	ÉCROU RAINURE M10 STRUT A4/316	529038	4.500
	100	ÉCROU RAINURE M12 STRUT A4/316	529039	4.300

RONDELLES L ET LL

	p	Désignation	Code	Masse kg/100
EZ	100	L Ø6 EZ	648024	0.500
	100	L Ø8 EZ	648020	0.700
	100	L Ø10 EZ	648034	1.200
	100	L Ø12 EZ	648023	1.700
	100	LL Ø6 EZ	648200	0.400
	100	LL Ø8 EZ	648201	0.400
GM	100	L Ø6 GM	651024	0.600
	100	L Ø8 GM	651020	0.700
	100	L Ø10 GM	651034	0.800
	100	L Ø12 GM	651023	1.700
	100	LL Ø6 GM	030446	0.400
	100	LL Ø8 GM	651703	0.400
I3	100	L Ø6 A4/316	529024	0.500
	100	L Ø8 A4/316	529020	0.800
	100	L Ø10 A4/316	529034	1.400
	100	L Ø12 A4/316	529023	1.700
	100	LL Ø6 A4/316	529300	1.000
	100	LL Ø8 A4/316	529301	1.000

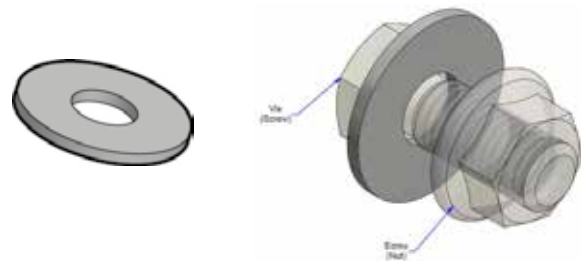
RONDELLE CONTACT

	p	Désignation	Code	Masse kg/100
EZ	100	RONDELLE A PICOTS M Ø6 EZ	040051	0.100

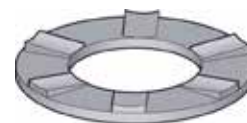



BOULONNERIE
RONDELLES AZ

		Désignation	Code	Masse kg/100
EZ	100	AZ Ø6 EZ	648029	0.100
	100	AZ Ø8 EZ	648033	0.100
	100	AZ Ø10 EZ	648030	0.100
	100	AZ Ø12 EZ	648014	0.200



TIGES FILETÉES

		Désignation	Code	Masse kg/p
EZ	10	TF M6 1M EZ	023100	0.170
	10	TF M8 1M EZ	023101	0.310
	10	TF M10 1M EZ	023102	0.500
	10	TF M12 1M EZ	023103	0.700

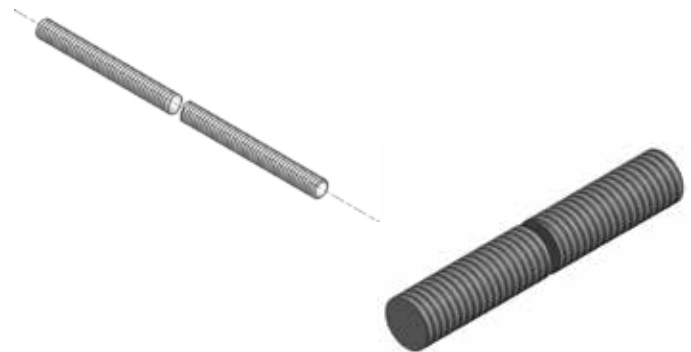

		Désignation	Code	Masse kg/p
I2	10	TF M6 1M A2/304	223200	0.180
	10	TF M8 1M A2/304	223151	0.310
	10	TF M10 1M A2/304	040100	0.500
	10	TF M12 1M A2/304	223253	0.700

		Désignation	Code	Masse kg/p
I3	10	TF M6 1M A4/316	223100	0.180
	10	TF M8 1M A4/316	646003	0.336
	10	TF M10 1M A4/316	646018	0.500
	10	TF M12 1M A4/316	223153	0.700

MANCHONS

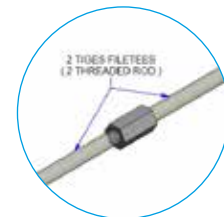
		Désignation	Code	Masse kg/100
EZ	100	MANCHON TF M12 EZ	023203	7.200
	100	MANCHON TF M10 EZ	023202	4.200
	100	MANCHON TF M8 EZ	023201	1.800
	100	MANCHON TF M6 EZ	023200	1.400



GOUPILLES

		Désignation	Code	Masse kg/100
EZ	100	V7x80 EZ	023050	2.300
	100	V8x90 EZ	023051	3.500
		Désignation	Code	Masse kg/100
I3	1	V8x90 A4/316	646002	3.500

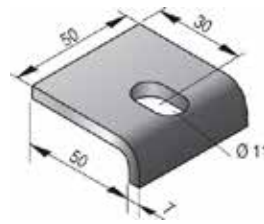

CRAPAUDS
CRAPAUDS HSK

p	Désignation	Code	Masse kg/p	Ep. mm
GC	50 HSK.10 GC	195800	0.150	7
	50 HSK.15 GC	195909	0.180	7
	50 HSK.20 GC	196104	0.200	7
	50 HSK.25 GC	196203	0.240	7
	50 HSK.30 GC	196005	0.300	7
	50 HSK.35 GC	196302	0.360	7
	50 HSK.40 GC	196401	0.440	7



Recommandés pour fortes charges sur charpentes métalliques avec profils **STRUT 41** ou **UPN**.





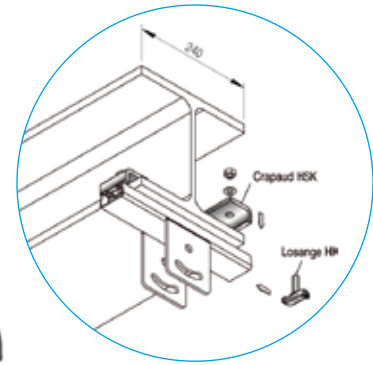
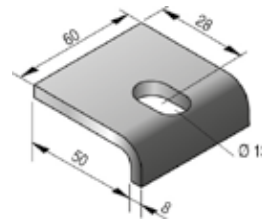

CRAPAUDS HSKS

p	Désignation	Code	Masse kg/p	Ep. mm
GC	25 HSKS.10 GC	196425	0.210	8
	25 HSKS.15 GC	196432	0.250	8
	25 HSKS.20 GC	196449	0.270	8
	25 HSKS.25 GC	196456	0.330	8
	25 HSKS.30 GC	196463	0.410	8
	25 HSKS.35 GC	196470	0.490	8
	25 HSKS.40 GC	196487	0.600	8



Recommandés pour fortes charges sur charpentes métalliques avec profils **STRUT 41** ou **UPN**.

Prévoir boulonnerie selon tableau ci dessous :

ÉPAISSEUR À SERRER (MM)	PROFIL OU PRODUIT À FIXER	CODE	CRAPAUDS	BOULONNERIE
5→9	STRUT 41  UPN 40 U.5050* 	195800	Crapaud HSK.10	 Prévoir : boulonnerie M10x30 + écrou H ou losange M10 Prévoir : boulonnerie M10x50 + écrou H ou losange M10 Prévoir : boulonnerie M10x60 + écrou H ou losange M10
10→14		195909	Crapaud HSK.15	
15→19		196104	Crapaud HSK.20	
20→24		196203	Crapaud HSK.25	
25→29	STRUT 41  UPN 40 U.5050* 	196005	Crapaud HSK.30	 Prévoir : boulonnerie M12x35 + écrou H ou losange M12 Prévoir : boulonnerie M12x50 + écrou H ou losange M12
30→34		196302	Crapaud HSK.35	
35→39		196401	Crapaud HSK.40	
20→24		196425	Crapaud HSKS.10	
25→29	196432	Crapaud HSKS.15		
30→34	196449	Crapaud HSKS.20		
35→39	196456	Crapaud HSKS.25		
	196463	Crapaud HSKS.30		
	196470	Crapaud HSKS.35		
	196487	Crapaud HSKS.40		

*Pour accessoires U.5050 : prévoir boulon losange HK

MISE À LA TERRE

Équipotentialité et mise à la terre

En France, le chemin de câbles métallique ne peut servir de conducteur PE.

Il s'agit donc de relier le cheminement au circuit de masse* pour augmenter le maillage global, améliorer l'équipotentialité et évacuer les perturbations électromagnétiques.

Ceci s'effectue avec les bornes ou griffes de mise à la terre et câbles.

* UTE C 15-900 36.7.2.4 : relier à la masse tous les 15 mètres ou aux extrémités si la longueur est inférieure à 15 mètres.

AGRAFE F-CLIP



p	Désignation	Code	Masse kg/p
AE	40 F-CLIP 16-35 AE	651314	0.019

- Montage rapide, simple et sans outils
- Compatible toutes finitions

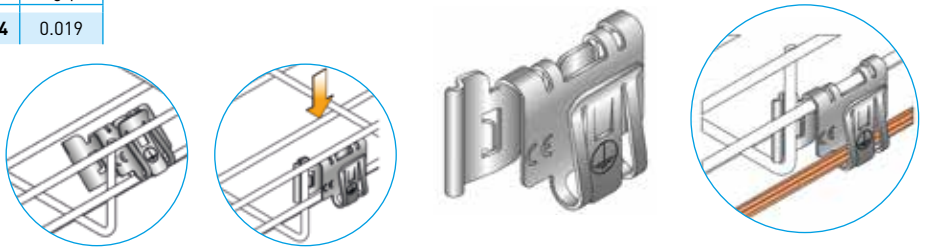

AGRAFE T-CLIP

p	Désignation	Code	Masse kg/p
AE	30 T-CLIP 16-35 AE	651313	0.017

Liaison équipotentielle des chemins de câbles en tôle perforée

Montage rapide, simple et sans outil
Existe également pour le chemin de câbles fil

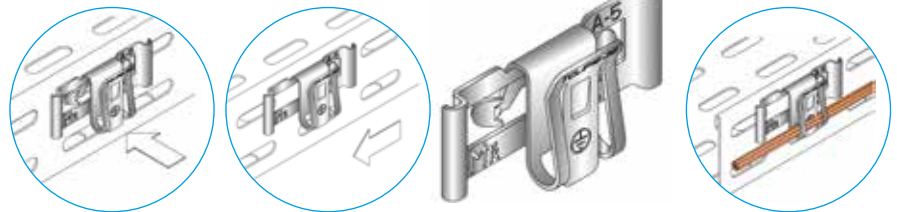

BORNES MT

p	Désignation	Code	Masse kg/p
LT	20 BORNE MT 6-25 mm ²	651310	0.045
	20 BORNE MT 6-35 mm ²	651309	0.072
	20 BORNE MT 6-50 mm ²	651303	0.072
	20 BORNE MT 6-95 mm ²	651300	0.080

- Livrée avec 2 rondelles AL-Cu + vis TRL M6x10 EZ
- Compatible toutes finitions

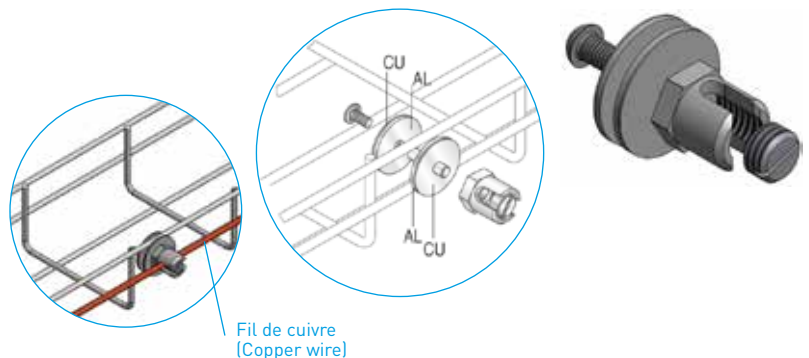

GRIFFE MT 10/50

p	Désignation	Code	Masse kg/p
LT	25 GMT 10/50	651311	0.040

Compatible toutes finitions

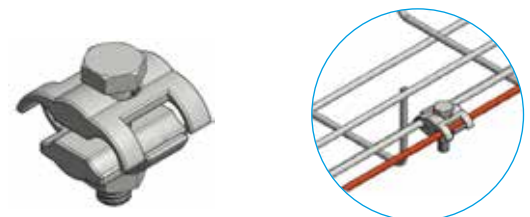

TRESSE DE MASSE

p	Désignation	Code	Masse kg/p
LT	50 TRESSE 16 mm ² L 100mm	651500	0.026





AUTRES ACCESSOIRES

BANDES PERFOREES

p	Désignation	Code	Masse kg/p	Ep. mm	L mm	ø mm
SZ	10 BANDE PERFOREE 12x0.8 10M SZ	601326	0.540	1.00	12	5
	10 BANDE PERFOREE 17x0.8 10M SZ	677383	0.730	1.00	17	7
	10 BANDE PERFOREE 26x1.0 10M SZ	677384	1.540	1.00	26	8



BOMBES AEROSOL

p	Désignation	Code	Masse kg/p
1	BOMBE GALVAPACK	023550	0.550

p	Désignation	Code	Masse kg/p
1	BOMBE AEROSOL IVOIRE 1	085041	0.520
1	BOMBE AEROSOL JAUNE 7 RAL 1003	085042	0.520
1	BOMBE AEROSOL ORANGE RAL 2009	085043	0.520
1	BOMBE AEROSOL ROUGE 1 RAL 3020	085044	0.520
1	BOMBE AEROSOL BRUN RAL 8014	085045	0.520
1	BOMBE AEROSOL BLANC 4 RAL 9003	085046	0.520
1	BOMBE AEROSOL NOIR 19 RAL 9005	085047	0.520
1	BOMBE AEROSOL GRIS 1 RAL 7004	085048	0.520
1	BOMBE AEROSOL BLEU 24 RAL 5015	085049	0.520
1	BOMBE AEROSOL BLEU 49 RAL 5013	085050	0.520
1	BOMBE AEROSOL VERT 49 RAL 6024	085051	0.520
1	BOMBE AEROSOL VERT RAL 6005	085052	0.520



JONCS DE PROTECTION A LA PIÈCE

p	Désignation	Code	Masse kg/p
PVC	10 JONC GRIS (10M)	040037	0.450
	10 JONC 500 NOIR (20M)	030457	1.600

Pour bords de tôles

- Jonc gris pour épaisseurs de tôle : **0,70 à 1,80 mm**, vendus en rouleau de 10 m (type BS/PS ou équivalent)
- Jonc noir pour épaisseurs de tôle : **1,50 à 2,50 mm**, vendus en rouleau de 20 m (type BRP ou équivalent)

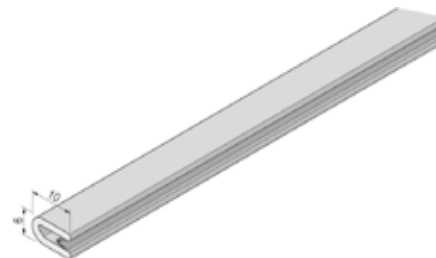

JONC DE PROTECTION AU MÈTRE

p	Désignation	Code	Masse kg/p
PVC	10 JONC 500 NOIR (1M)	030481	0.080

Pour bords de tôles **d'épaisseurs de 1,50 à 2,50 mm** (type BRP ou équivalent)

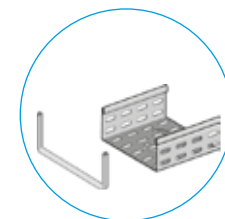
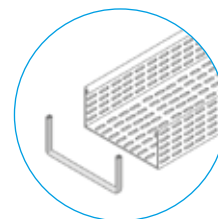

AUTRES ACCESSOIRES
PLOT BETON

p	Désignation	Code	Masse kg/p
PVC	20 PLOT BETON PVC	088295	0.995

Applications pour Dalles et Fil en toitures terrasse
Fixation des chemins de câbles par vis TRL 6x12, GM 651483

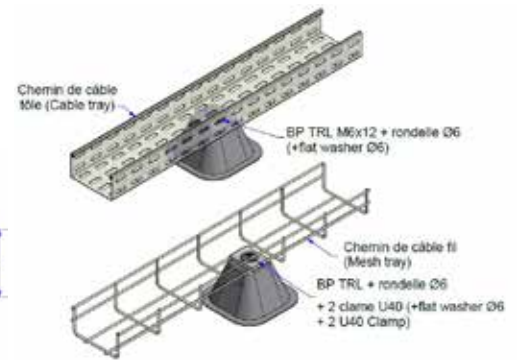
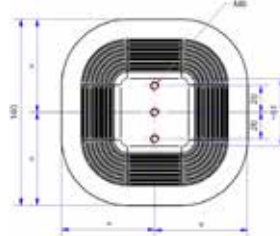
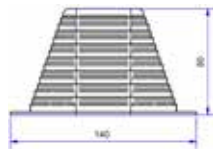
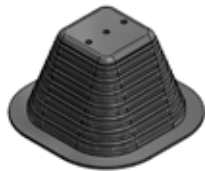
CROCHETS 1712/1 ET 712/1

p	Désignation	Code	Couleur	H1 mm	H2 mm	L1 mm	L2 mm	Masse kg/100
PP	50 1712/1 PP	700790	Blanc	70	80	29	40	1.890
	50 712/1 PP	700792	Blanc	70	80	29	40	1.800

- Pour maximum 15 câbles NYM 3x1.5 mm²
- Préconisés pour fixation murale et plafond
 - A utiliser avec une cheville à frapper de diam. 6mm
 - Distance de fixation recommandée 0.5 - 0.6 mm
- Résistance au fil incandescent :
- 1712 → 750°C
 - 712 → 960°C

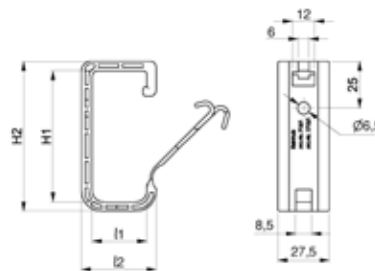
CROCHETS 1712/2 ET 712/2

p	Désignation	Code	Couleur	H1 mm	H2 mm	L1 mm	L2 mm	Masse kg/100
PP	25 1712/2 PP	700788	Ral 7035	105	120	45	60	2.930
	25 712/2 PP	700791	Ral 7035	105	120	45	60	2.930

- Pour maximum 30 câbles NYM 3x1.5mm²
- Préconisés pour fixation murale et plafond
 - A utiliser avec une cheville à frapper de diam. 6mm
 - Distance de fixation recommandée 0.5 - 0.6 mm
- Résistance au fil incandescent :
- 1712 → 750°C
 - 712 → 960°C

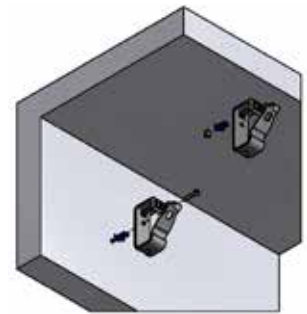
BRIDES DE CABLES

p	Désignation	Code	Couleur	H mm	L mm	L1 mm	B mm	Masse kg/100
POM	25 794/100 POM	700764	Blanc	12,0	126,5	46,5	14,5	0.670
	25 794/200 POM	700765	Blanc	15,5	219,5	86,0	20,0	1.780

- Avec trous de fixation de diam. 6mm
Couleur Blanc
- 794/100 : pour max. 8-10 câbles NYM 3x1.5 mm²
 - 794/200 : pour max. 16-20 câbles NYM 3x1.5 mm²

